



SPIRIT

By Soundcraft

SPIRIT LIVE 4

USERS GUIDE

SPIRIT LIVE 4



Thank you for purchasing a **SPIRIT LIVE 4** mixer, brought to you with pride by the **SPIRIT** team of Andy, Anthony, Bob, Colin, David, George, George, Graham, Ian, Jean Luc, Peter, Prasanna and Simon, with the support of many others - we hope you will have as much fun using it!

© Soundcraft Electronics Ltd. 1992

All rights reserved

Parts of the design of this product may be protected by worldwide patents

Issue 1

Part No. ZZ2832

Information in this manual is subject to change without notice and does not represent a commitment on the part of the vendor. Soundcraft Electronics Ltd. shall not be liable for any loss or damage whatsoever arising from the use of information or any error contained in this manual.

No part of this manual may be reproduced, stored in a retrieval system, or transmitted, in any form or by any means, electronic, electrical, mechanical, optical, chemical, including photocopying and recording, for any purpose without the express written permission of Soundcraft Electronics Ltd.

It is recommended that all maintenance and service on the product should be carried out by Soundcraft Electronics Ltd. or its authorised agents. Soundcraft Electronics Ltd. cannot accept any liability whatsoever for any loss or damage caused by service, maintenance or repair by unauthorised personnel.

Soundcraft Electronics Ltd.
Cranborne House,
Cranborne Industrial Estate,
Cranborne Road,
Potters Bar,
Hertfordshire,
EN6 3JN
England

Tel: (+44) 707 665000

Fax: (+44) 707 660482



User Guide

Contents

Introduction	2
Basic Principles of PA Mixing	3
Getting Started	6
Connections and Connectors	6
Fault Finding Guide	9
Getting to know your console	10
Facilities	10
Input Channel	10
Stereo Sections	15
Group Sections	17
Master Section	18
Using your SPIRIT LIVE 4 Console	20
Initial Set Up	20
Applications	22
Public Address	22
Recording	24
Care of your mixer	25
Glossary	25
Selectable Options	27
Specifications	29
Front Panel Layout	fold out rear cover
Block Diagram	inside rear cover



INTRODUCTION

Congratulations on your purchase of a **SPiRiT LIVE 4** mixer. Owning a Soundcraft console brings you the expertise and support of one of the industry's leading manufacturers and the results of over 20 years experience supporting some of the biggest names in the business.

Designed by engineers who understand the individual needs of musicians, **SPiRiT LIVE 4** has been built to the highest standards using quality Japanese components and employing automated assembly techniques beyond the reach of most manufacturers of compact mixers.

A rugged steel chassis is combined with moulded side trims to give protection and distinctive appearance. Custom moulded controls, designed for the best 'feel' and visual clarity complement the styling, resulting in a truly professional product which is ideal for both touring and fixed PA installations.

SPiRiT LIVE 4 is available in 12, 16, 24 and 32 channel frame sizes, and the 12 and 16 channel sizes may be extended by adding an 8 channel Expander. The Expander can be attached quickly and securely to the console, requiring only a screwdriver to complete the installation.

SPiRiT LIVE 4 incorporates circuit technology identical to that used on some of the most sophisticated Soundcraft consoles. The input channels are able to accept a wide range of Microphone and Line level signals from separate input sockets. Every channel features wide range gain control and Line input pad, 3-band Equalisation with swept Mid and LF range, plus a Hi-Pass Filter, 5 Auxiliary Sends, PFL(Pre Fade Listen), Peak LED, Panning to a Stereo Bus and routing in pairs to four Output Groups. Each channel has a separate Direct Output and is controlled by a high-quality long throw fader.

All frame sizes are provided as standard with dedicated stereo inputs, arranged in pairs. One pair is included on the 12 channel frame and two pairs on all other frame sizes. Each stereo input includes a 2-band EQ and a single auxiliary send control with switching which allows prefade or postfade sourcing with access to three of the five Auxiliary busses. The stereo channel signal may be routed to either the Mix output or to Groups 1 & 2 (upper) or Groups 3 & 4 (lower).



The four Output Groups provide submixing to the Mix L/ R outputs or may feed external equipment directly. Each incorporates stereo panning and PFL monitoring or bargraph metering and includes an external Return input for effects or submixing from external sources.

The Master section provides master level control for the Left, Right, Mono and Auxiliary Send busses, with separate AFL monitoring on each Auxiliary Send and the Mono output.

The Mix L/ R and Group outputs all have insert points for the connection of external signal processing.

Comprehensive Talkback facilities are provided, which allow an external talkback microphone to be routed to Mix L/ R, Groups and Auxes 1 & 2 as required. Six 12-segment, 3-colour peak reading LED bargraph meters provide clear display of Mix L/ R, Group and PFL signals. Pressing any PFL or AFL switch puts the selected signal onto both sides of the headphones output, and the right bargraph meter.

SPIRIT Live 4 is designed to be as user-friendly as possible, but a few minutes spent reading through this manual will help you become familiar with the product away from the pressure of a live session, and allow you to gain full benefit from the superb performance offered by your new mixer.

Above all, remember that your SPIRIT mixer is designed to extend your creativity. The more you explore the controls and the effect they have on the sound output, the more you will appreciate how you can influence and enhance the final sound.

BASIC PRINCIPLES OF PA MIXING

There was a time when the P.A. system and the operator existed only to increase the overall volume of the performers, so that they could be heard in a large room or above high ambient noise levels. This just isn't true any more. The sound system and the sound engineer have become an integral part of the performance, and the artists are heavily dependent on the operator's skill and the quality of the equipment.

The following introduction to the basics of mixing are included for the benefit of those users who may not have any significant familiarity with sound equipment, and who are baffled by the endless jargon used by engineers and artists alike.



The Mixer

As one would expect, the main purpose of the mixer is to combine sounds, but under precise and smooth control. This is why long-throw faders are essential on any professional product. The faders provide you with clear and instinctive control of the final sound balance and like an artist playing an instrument you should listen to the effect of your fader movements, not look at your hands.

Your **SPIRIT LIVE 4** mixer accepts a wide range of input signals via a microphone input, for very low level signals, or a line input, for higher level signals from, for instance, tape machines, effects processors, etc.

The mixer is split into two sections. The **Inputs** receive, match and process individual source signals, and distribute them at precise mix levels to either a stereo **Mix** output or to one of the **Groups**. The **Master** section allows overall level control of all outputs, and provides monitoring of the audio signal at many points in the mixer, either on headphones or meters.

The **Equaliser** controls are the most flexible and potentially destructive feature of the mixer. They have a similar effect on the frequency response of the input channel as the tone controls on a hi-fi system, but with much greater precision, and allow particular characteristics of the input signal to be emphasised or reduced. It is very important that you become familiar with the effect each control has on the sound and this is best achieved by spending time *listening* to the effect of each control on a well-known track played through the mixer.

The **Auxiliary Sends** provide a way of routing the input signals to a number of secondary outputs, for artists foldback, echo units or additional speaker outputs.

The **Pan** control adjusts the position of the input signal within the stereo mix, and can be swept from full left, through to full right. This allows particular artists to retain their correct spatial position within the mix, and can be valuable for live effects.

Pre-Fade-Listen(PFL) allows you to monitor the signal at many points in the mixer. Pressing any PFL switch places the signal at that particular point onto the headphones and the right meter, to check the quality of the signal or to pin-point problems. Using PFL will not affect the signals on the outputs from the desk.

Each input channel and the three main outputs have an **Insert** 'A' gauge jack socket, which is a break point in the signal path. It allows the signal to be taken out of the mixer, through an external piece of equipment and then back into the mixer directly after its original exit point. The Insert point is normally bypassed by the 'A' gauge jack socket contacts, and is only brought into operation when a plug is inserted. Typical uses would include Effects Processors, Limiters, additional Equalisers or Delay units. In addition, each channel has a **Direct** output which may also be used to feed external equipment.

The terms **PRE** and **POST** are often used in the context of Inserts, Equalisers and Auxiliary Sends, and describe whether that facility is placed before (Pre) or after (Post) another particular section. This is explained further in the detailed description of facilities.

A mixer is often judged, amongst other factors, by the amount of **Headroom** available. This is a measure of the reserve available to cope with sudden peaks in the input signal, without distortion caused by **Clipping**, when the signal becomes so high that it would exceed the power supply rail voltages and is as a result limited. This commonly occurs where gain settings are incorrectly set or where sources are improperly matched to the mixer input. If the source signal is too high, clipping and distortion results. If the signal is too low it becomes masked by the background noise which is present to some degree in all mixers. The diagram below illustrates this point.

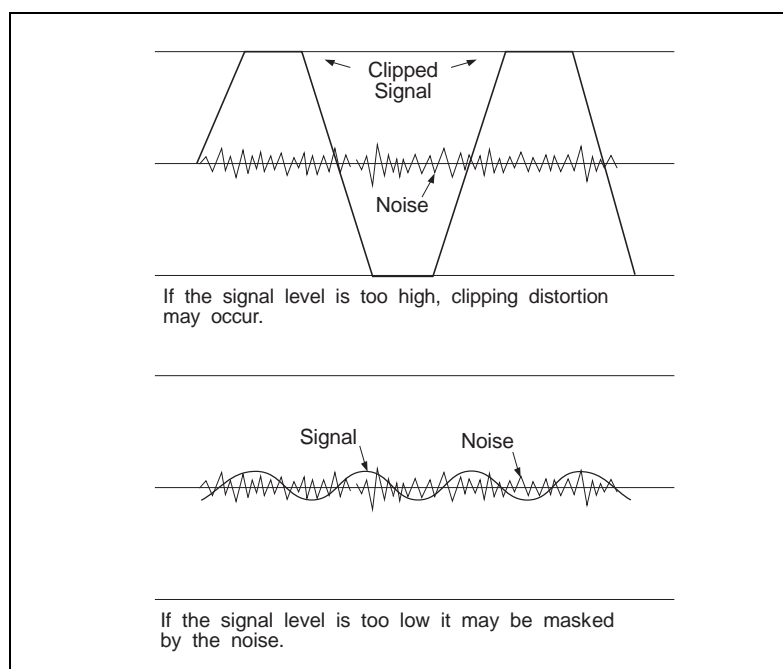

GETTING STARTED

CONNECTIONS AND CONNECTORS

Although this may seem a simple subject, *faulty connectors and cabling are the source of most sound system problems.* Correctly-made cables of the proper type, with the right connectors for the job will ensure peak performance from your system with minimum noise pick-up. The following section will help you to connect **SPIRIT LIVE 4** correctly.

Two different types of audio connectors are used, 3-pin XLR and 1/4" three pole ('A' gauge) jacks. These are used in several configurations as shown in the diagrams below.

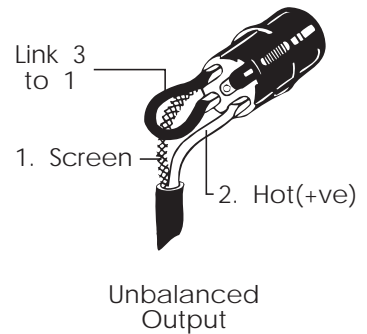
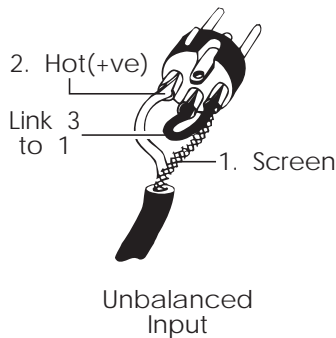
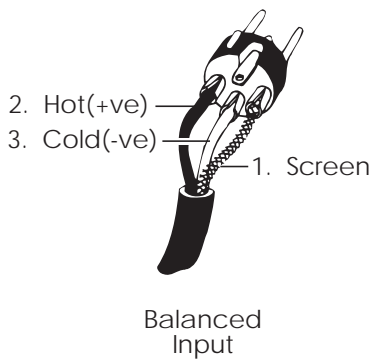

————— 3 POLE (stereo) JACK —————

————— 2 POLE (mono) JACK —————

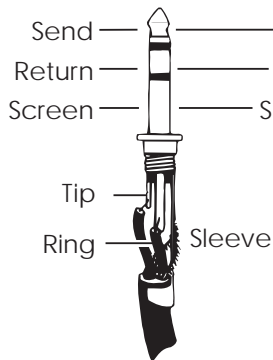

Insert Points

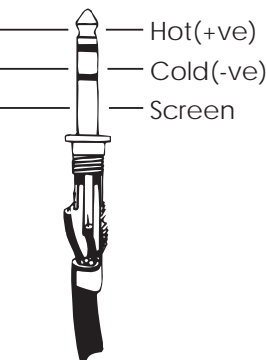

Line Input
Aux Outputs
FX Returns
Direct Outputs

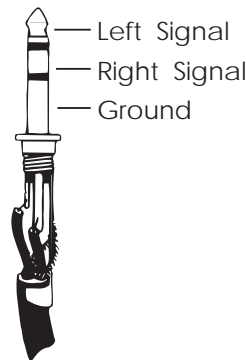

Headphones

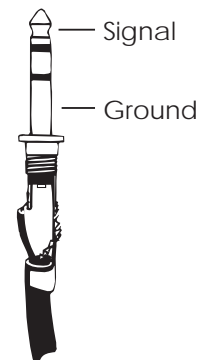

Unbalanced Output
(see text)



Balanced and Unbalanced

All channel inputs are balanced, i.e. there are separate +ve(hot) and -ve (cold) wires for each signal plus a ground. The design of the differential input amplifiers is such that interference picked up on these wires is cancelled out. This is because, since both wires are in close proximity, the *same* interference will be picked up on each wire and balanced input amplifiers will only amplify the *difference* between +ve(hot) and -ve(cold). Any signal on both hot and cold (i.e. noise) will not be amplified - this is known as common mode rejection (CMR). Balanced inputs should always have both +ve and -ve connected or if only an unbalanced source, the -ve pin shorted to ground.

Note: many modern audio/ musical instruments have electronically balanced outputs which should not be unbalanced by shorting one wire to ground. Always use your inputs balanced where possible.

The Mix L/ R and Mono outputs, Group and Auxiliary outputs are **ground compensated** and provide a very effective way of optimising noise immunity, without the cost and complexity of balanced outputs. These outputs employ ground compensation techniques to cancel out the effects of variation in ground potential between the mixer and other equipment which would otherwise show up as hum. If the output is driving a device or amplifier that has an unbalanced input, connect the -ve(cold) signal to the ground at the destination, not at the output of your **SPIRIT LIVE 4** console.

Polarity

You will probably be familiar with the concept of polarity in electrical signals and this is of particular importance to balanced audio signals. Just as a balanced signal is highly effective at cancelling out unwanted interference, so two microphones picking up the same signal can cancel out, or cause serious degradation of the signal if one of the cables has the +ve and -ve wires reversed. This **phase reversal** can be a real problem when microphones are close together and you should therefore take care always to connect pins correctly when wiring audio cables.

Grounding and Shielding

For optimum performance it is vital that all signals are referenced to a solid, noise-free earthing point and that all signal cables have their screens connected to ground. To avoid earth 'loops', use balanced connections where possible and ensure that all cable screens and other signal earths are connected to ground only at their source and **not** at both ends.

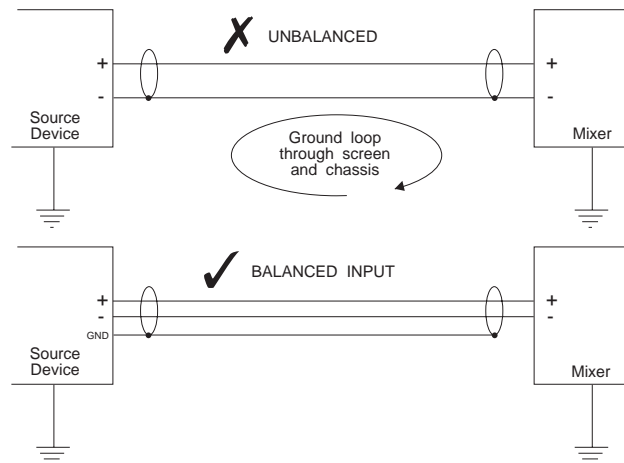

If the use of unbalanced connections is unavoidable, you can minimise noise by following these wiring guidelines:

- On INPUTS, unbalance at the source and use a twin, screened cable as though it were balanced. (see below)
- On OUTPUTS, connect the signal to the +ve output pin, and the ground of the output device to -ve. If a twin screened cable is used, connect the screen only at the mixer end. (see below)

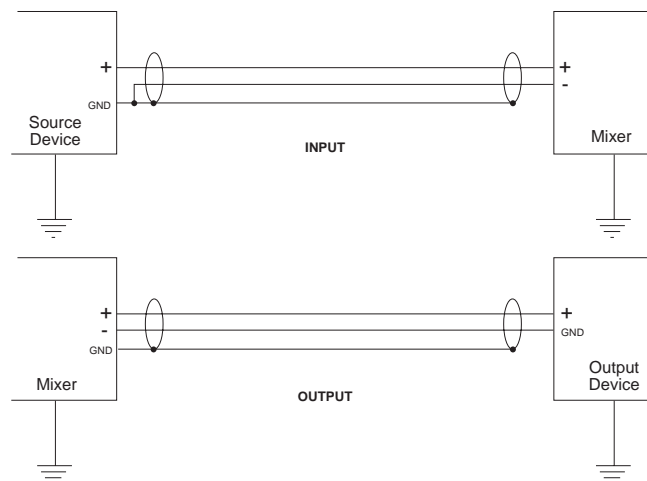

Avoid running audio cables or placing audio equipment, close to thyristor dimmer units or power cables.

Noise immunity is improved significantly by the use of **low impedance** sources, such as good quality professional microphones or the outputs from most modern audio equipment. Avoid cheaper high impedance microphones, which may suffer from interference over long cable runs, even with well-made cables.



Fault Finding Guide

Repairing a sound mixing console requires specialist skills, but basic *Fault Finding* is within the scope of any user if a few basic rules are followed.

- Get to know the Block Diagram of your console (see inside rear cover)
- Get to know what each component in the system is supposed to do.
- Learn where to look for common trouble spots.

The **Block Diagram** (see inside rear cover) is a representative sketch of all the components of the console, showing how they connect together and how the signal flows through the system. Once you have become familiar with the various component blocks you will find the Block Diagram quite easy to follow and you will have gained a valuable understanding of the internal structure of the console.

Each **Component** has a specific function and only by getting to know what each part is supposed to do will you be able to tell if there is a genuine fault! Many 'faults' are the result of incorrect connection or control settings which may have been overlooked.

Basic **Troubleshooting** is a process of applying logical thought to the signal path through the console and tracking down the problem by elimination.

- Swap input connections to check that the source is really present. Check both Mic and Line inputs.
- Eliminate sections of the channel by using the insert point to re-route the signal to other inputs that are known to be working.
- Route channels to different outputs or to auxiliary sends to identify problems on the Master section.
- Compare a suspect channel with an adjacent channel which has been set up identically. Use PFL and AFL to monitor the signal in each section.



GETTING TO KNOW YOUR CONSOLE

Refer to the fold-out front panel diagram which shows the control functions on the **SPIRIT LIVE 4**. Each facility is described below, and is identified by the reference number.

FACILITIES

INPUT CHANNEL

1.

MICROPHONE INPUT

The Microphone input is via a standard female XLR-3 connector and is available when the **LINE -20dB** switch is released. It is designed to accept a wide range of balanced or unbalanced low impedance input signals.

+48V Phantom Power is available on each input microphone socket. This is switched on globally from the power supply in the case of the 12, 16 and 24 channel desks, or from a rocker switch adjacent to the d.c. power connector at the top right of the 32 channel desk. Should you wish to configure inputs without +48V power, see Selectable Options on Page 27 for details of this modification.

Transformer-coupled dynamic microphones may be used without causing damage, even when the +48V power is connected, but care must be taken when using unbalanced sources, because of the voltage present on pins 2 and 3 of the XLR connector. Microphone input level is set by the **GAIN** control(6).

NOTE: Phantom powered mics should not be plugged in with the +48V switched on. Also you should be aware that some microphones draw an unusually large current which may overload the power supply, resulting in distortion. Consult your microphone supplier for guidance if necessary.

2.

DIRECT OUTPUT

A ground compensated **DIRECT** output is provided, fed from the output of the fader buffer, which is therefore unaffected by the position of the **ROUTING** switches or **PAN** control. This provides an ideal source for external processing units, the output of which may be brought back to the console through the **STEREO** sections or group **RETURNS**, or to directly send to the tracks of a tape machine for multitrack recording. This provides as many Tape Sends as there are mixer channels, without using the group or mix outputs.



3. LINE INPUT

The LINE Input is a 3-pole ¼" 'A' gauge jack socket, to accept balanced or unbalanced line level sources when the LINE switch(5) is pressed. Unlike the low impedance Microphone input, this stage presents a high impedance(>10kΩ) to the input signal, enabling many types of instruments to be plugged straight in without D.I. boxes or external preamplifiers.

Line inputs will be found useful as extra Effects Returns, where additional post-effect equalisation is required.

4. INSERT

The **INSERT** is a break point in the input channel signal path. It allows the signal to be taken out of the mixer, through an external piece of equipment and then back into the mixer to continue through to the final output. The Insert is a 3-pole ¼" 'A' gauge Jack Socket, which is normally by-passed. When a jack plug is inserted, the signal path is broken at a point just after the Hi-Pass Filter, but before the EQ section. **The signal from the channel appears on the TIP of the plug and is returned on the RING.** The insert point allows limiters, compressors and other signal processing units to be added as required to particular input channels and because it is located PRE EQ, noise generated by the external equipment may be reduced by a small amount of H.F. cut in the Equaliser.

5. LINE SELECT

The LINE switch selects Line input when pressed, and Microphone input when released. When Line is selected the Gain range is reduced by 20dB (see 6 below).

6. GAIN CONTROL

When the Microphone input is selected this control acts as a **SENSITIVITY** control covering a 50dB range. Channel signal level increases as the control is turned clockwise. When the Line input is selected it serves as a **GAIN** control, with the scaling reduced by -20dB from the printed scale. A nominal 0dB input signal will pass through at unity gain, with the knob set at the 20dB position. Some audio equipment, particularly that intended for domestic use, operates at a nominal -10dBV level and an increased Gain setting will be required.



7.

HI-PASS FILTER

Pressing this switch inserts a 12dB per octave 100Hz Hi-Pass Filter in the signal path, immediately after the input amplifier. This is particularly useful on live vocals, and its use is strongly recommended, even on male vocals. It can also be used for filtering out low frequency hum.

Frequency Response Curves of the Hi-Pass Filter

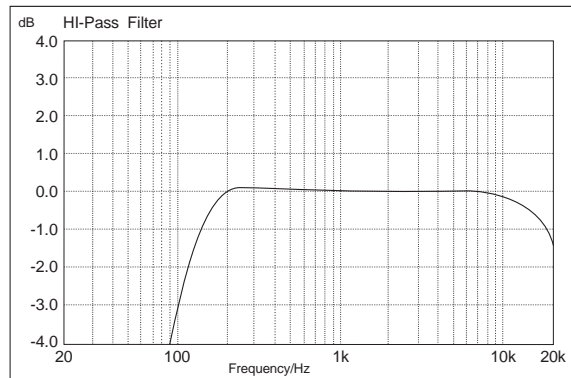

8.

EQUALISER

The Equaliser(EQ) comprises three sections. The upper control provides H.F.(treble) boost and cut of +/- 15dB. The lower two pairs of knobs are arranged as a cut/ boost control (lower knob) of +/- 15dB, and a SWEEP(frequency) control which determines at which frequency the boost/ cut action will be centered. The LF sections are essentially Swept Low Frequency controls, covering a range from 40 to 400Hz and providing much greater flexibility than a conventional LF(bass) control. The MID section, with a frequency range from 250Hz to 8kHz is particularly versatile for vocals, enabling particular characteristics of the singer to be lifted or suppressed very precisely.

Frequency Response Curves of the Equaliser

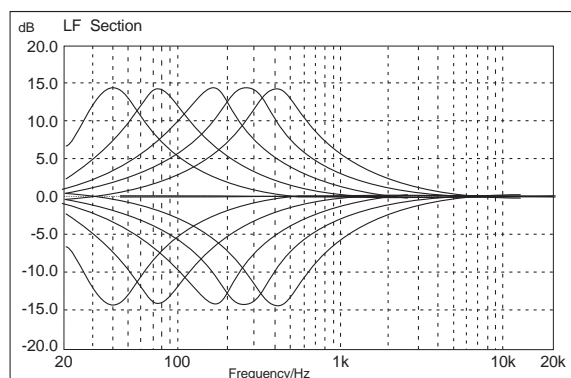



Frequency Response Curves of the Equaliser

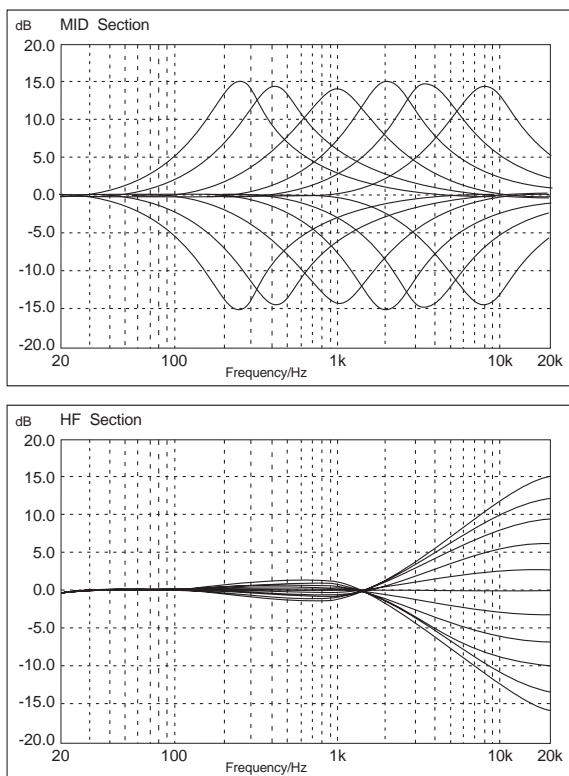

9.

AUXILIARY SENDS

These controls route the input channel signal to any one or more Auxiliary busses. These are separate from the main outputs and can therefore provide additional outputs for foldback, echo units or extra loudspeaker 'fills'.

AUX 1 & 2 are derived before the channel fader(PRE FADE), and are therefore unaffected by the fader position. This makes them particularly suitable for foldback or monitor feeds, which need to be controlled separately from the main P.A. mix.

AUX 3, 4 and 5 are derived after the channel fader(POST FADE), and therefore follow any changes in fader level. They are normally used to drive effects processing units which are fed back into the mixer and which must fade out with the input channel.

AUX 2 may be altered internally to be POST FADE. Refer to the Selectable Options section (Page 28) for a description of this modification.

All of the Aux Sends are muted when the **ON** switch(12) is released.



10.

PAN

The **PAN** control determines the position of the signal within the stereo mix image or may be used to route the channel signal to particular output **GROUPS** as selected by the **ROUTING SWITCHES** (13). Rotation fully anticlockwise feeds the signal solely to the Left mix buss or Groups 1 and 3, while rotation clockwise sweeps the image to the right buss or Groups 2 and 4.

11.

PFL/ PEAK LED

When the **PFL** switch is pressed, the Pre-Fade signal is fed to the headphones, where it replaces the selected source. The **PFL/AFL LED** on the master section illuminates to warn that the headphones and the meters are now responding to the PFL/ AFL selection and the PFL LED on the input channel lights to identify the active channel. This is a useful way of listening to any required input signal without interrupting the main mix, for making adjustments or tracing problems.

When the PFL switch is released the LED on the channel serves as a **PEAK** indicator, to warn when an excessively high signal level is present in the channel. The signal is sampled at two points in the channel, immediately after the input amplifier (PRE HI-PASS FILTER & PRE INSERT) and POST EQ. The Peak LED will illuminate approximately 4dB before clipping and therefore give warning of a possible overload even if the peaks are removed by external equipment plugged into the Insert.

12.

ON SWITCH

The **ON** switch enables all outputs from the channel when pressed, and the associated LED illuminates to show that the channel is active.

13.

ROUTING SWITCHES

The input channel signal may be routed to the main STEREO MIX (**L-R**) or pairs of GROUP busses (**1-2, 3-4**), by pressing the respective switches. These may be used in conjunction with the **PAN** control (10 above) to route the channel signal proportionately to any of the selected busses.

13.

CHANNEL FADER

This long-throw fader determines the proportion of the channel in the mix and provides a clear visual indication of channel level. Normal operating position is at the '0' mark, providing 10dB of gain above that point if required.



STEREO SECTIONS

1. STEREO INPUTS

Each Stereo Input section comprises a pair of similar inputs. The inputs are electronically balanced and separate jacks are provided for the Left and Right source signals. A mono signal may be plugged into the upper socket only for each pair to be fed equally to left and right busses.

2. -10 SWITCH

The input jacks are normally set to match +4dBu nominal signal levels. Pressing the **-10** switch alters the input sensitivity to match the -10dBV signals from most Hi-Fi systems or semi-professional tape machines allowing the inputs to be quickly switched to match, for instance, a cassette player for pre-show music.

3. EQUALISATION

Each Stereo Input is provided with a 2-band shelving EQ section giving ± 15 dB boost & cut at fixed frequencies of 60Hz and 12kHz.

Frequency Response Curves of the Equaliser

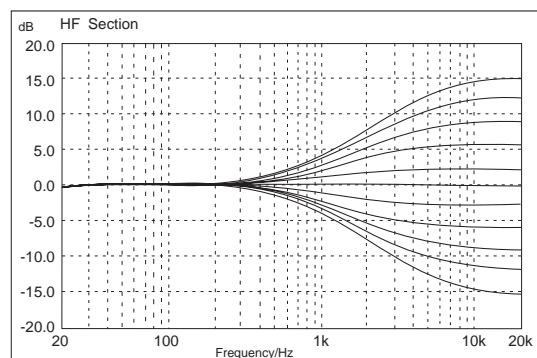
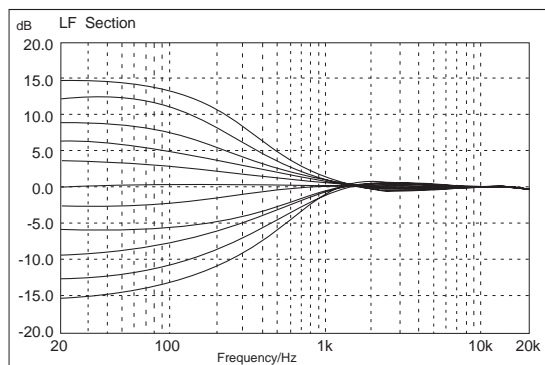



4. **AUX SEND**

A single control feeds a mono sum of the stereo signal to a choice of Aux Send busses (see 5 below).

5. **AUX SELECTION**

The flexibility of the Aux send control (4) is maximised by a choice of destinations on the two Stereo sections. On the upper section (Stereo 1) this switch routes the Aux Send to either **AUX 1** (Prefade) when released, or **AUX 3** (Postfade) when pressed. On the lower section the choice is between **AUX 1** (Prefade) when released and **AUX 4** (Postfade) when pressed.

6. **BALANCE**

The **BAL** control sets the relative level of the Left and Right signals. In the centre position its gain is unity. Turning the control fully clockwise increases the Right signal by +4dB, and totally kills the Left signal. Full anticlockwise rotation has the opposite effect. Balance left biases the signal to the Left buss and Groups 1 & 3, balance right to the Right buss and Groups 2 & 4.

7. **PFL**

When the PFL switch is pressed the prefade signal is fed to the Headphones where it replaces the selected source. The **AFL/PFL LED** on the Master Section illuminates to warn that the headphones and **RIGHT/PFL METER** are now responding to the PFL selection and the **PFL LED** on the Stereo Section lights to identify the active source.

8. **ON**

Pressing this switch turns ON the feeds to the Aux Sends and output busses. The associated LED illuminates to show that the section is active.

9. **ROUTING**

A single Routing Switch per section provides access to Mix **L-R** and Groups **1-2** or **3-4**. The upper section routes between Mix L-R with the switch released, and Groups 1-2 when pressed. The lower section routes between Mix L-R with the switch released and Groups 3-4 when pressed. The relative levels of the left and right signals is controlled by the **BALANCE** control (6).



10.

FADER

Linear faders are provided for precise and smooth level control for each Stereo section.

GROUP SECTION

1.

RETURN

A mono Return is provided to each output Group, which is intended for use as a sub-mix from another desk or as an effects input. The input is electronically balanced on a standard 1/4" 3-pole 'A' gauge jack.

2.

INSERT

An Insert is provided for each output Group to allow external processing equipment to be 'inserted' into the output path. The 1/4" 3-pole 'A' gauge jacks are bypassed except when a plug is inserted.

3.

RETURN LEVEL

The level of the signal at the **RETURN** input (1, above) is set by a rotary control. A panel marking indicates the nominal unity gain position.

4.

PAN

The Group **PAN** control determines the position of the signal within the stereo image which is routed to the mix L/ R busses when **L-R** is pressed. Rotation fully anticlockwise feeds the signal solely to the Left mix buss, while rotation clockwise sweeps the image to the right.

5.

PFL

When the **PFL** switch is pressed, the pre-fade Group signal is fed to the headphones and **RIGHT/PFL METER** where it replaces the mix signal. The **AFL/PFL LED** on the master section illuminates to warn that the headphones and meter are now responding to the AFL/ PFL selection and the **PFL LED** on the Group lights to identify the active Group.

6.

GROUP FADER

Long throw faders are provided for each Group with unity gain at the top of their travel.



7. GROUP OUTPUT

The Group outputs are driven by ground compensated amplifiers to a standard ¼" 3 pole 'A' gauge jack socket.

MASTER SECTION

8. D.C. POWER SOCKET

The cable from the power supply connects to the console via this 5-pin socket.

Ensure that you always use the correct power supply for your console. The 12, 16 and 24 channel frame sizes require the DCP100 power supply and the 32 channel frame uses the CPS150 power supply.

9. MONO OUTPUT

The ground compensated **MONO** output is a sum of the postfade Mix Left and Right outputs, providing a separately controlled feed which may for instance be used to drive a centre loudspeaker cluster via a suitable power amplifier.

10. MIX L & R OUTPUTS

The MIX L & R outputs are standard male XLR-3 connectors, driven by ground compensated amplifiers.

11. INSERTS

These are similar to the Input Channel Inserts and allow external processing equipment to be 'inserted' into the output signal path. The ¼" 3 pole 'A' gauge jack sockets are by-passed except when a plug is inserted.

12. BARGRAPH METERS

Six 12-segment, three colour bargraph meters provide visual monitoring of the levels of the Mix Left and Right, and Group outputs. All the meters are peak reading.

Normally the Left and Right meters show the level of the Mix Left and Right outputs. If any PFL or AFL switch is activated the left meter is turned off and the right meter displays the level of the selected PFL or AFL signal.

The bargraphs may be calibrated by trimmers accessed via holes in the panel below each meter. Adjustments may be made using a small screwdriver, taking care not to damage the trimmers.



13. MONO

The level of the **MONO** output (9) is set by a rotary fader. The associated **AFL** switch with indicating LED monitors the final output *after the fader*.

14. AUXILIARY MASTERS

Each of the Auxiliary Send busses is provided with a rotary master level control and an **AFL** switch with indicating LED which monitors the final output *after the fader*.

15. AUXILIARY OUTPUTS

The Auxiliary Send outputs are driven by ground compensated amplifiers to a standard 1/4" 3 pole 'A' gauge jack socket.

16. TALKBACK

A female XLR-3 connector provides the input for a headphone mounted, gooseneck or floating dynamic microphone for **TALKBACK** to selected outputs. Level is set by the **TB** control and three switches route the signal selectively to Mix **L-R**, Groups (**GRPS**) or **AUX 1-2**.

17. HEADPHONE VOLUME

This control sets the level of the **PHONES** output at the socket below the front armrest. Normally this is fed by the Mix L/ R output, unless an **AFL** or **PFL** switch is pressed, in which case the Mix signal is replaced by the **AFL/ PFL** signal and the **AFL/PFL LED** lights to show that the **AFL/ PFL** system is active.

Note that due to the way that the ground compensated outputs operate, it is possible that a hum might be audible under **AFL** listening, which is in fact cancelled on the actual output. This would indicate that there is a ground loop in your system which you may wish to correct.

18. MIX FADERS

Master faders for Left and Right mix outputs. Unity gain is at the top of their travel.

USING YOUR SPIRIT LIVE 4 CONSOLE

The final sound from your P.A. system can only ever be as good as the quality of the source signal. Just as you need to become familiar with the control functions of your mixer, so you must recognise the importance of correct choice of inputs, microphone placement and input channel settings. However, no amount of careful setting up can take account of the spontaneity and unpredictability of live performance and the mixer must be set up to provide 'spare' control range to compensate for changing microphone position and the absorption effect of a large audience (different acoustic characteristics from sound check to show).

The front panel drawing inside the rear cover shows typical initial control positions which may be found a useful guide to setting up the mixer for the first time.

Initial Set Up

The diagram on page 5 demonstrated how the matching of input gain to the signal source was crucial to avoid distortion at one extreme and excessive noise at the other. Set up individual input channel as follows:

- Connect the input required (microphone, keyboard etc.)
Note: Phantom powered mics should be connected before the +48V is switched on.
- Set Master faders at 0, input faders at 0, and set power amplifier levels to about 70%.
- Provide a typical performance level signal and press the PFL button on the particular channel, monitoring the level on the right-hand meter.
- Adjust the input gain until the meter is just reaching the amber section (0dB) at a typical maximum source level. This allows sufficient headroom to accommodate peaks and establishes the maximum level for normal operation (but see note below).
- Repeat this procedure on other channels as required. As more channels are added to the mix, the meters may move into the red section. Adjust the overall level using the Master Faders if necessary.



- If you cannot obtain a satisfactory setting, e.g. the gain control is right at the extreme low end of the scale on Microphone Input, try using the Line Input instead.
- Listen carefully for the characteristic sound of 'feedback'. If you cannot achieve satisfactory input level setting without feedback, check microphone and speaker placement and repeat the exercise.

You are now ready to start building the mix and this should be done progressively, listening carefully for each component in the mix and watching the meters for any hint of overload. If this occurs, back off the appropriate Channel Fader slightly until the level is out of the red segments, or adjust the Master Fader.

Note: The level of any source signal in the final output is affected by many factors, principally the Gain control, Channel Fader and Output Faders. You should try to use only as much microphone gain as required to achieve a good balance between signals, with the faders set as described above. If the input gain is set too high, the channel fader will need to be pulled down too far in compensation to leave enough travel for successful mixing and there is a greater risk of feedback because small fader movements will have a very significant effect on output level. If the gain is set too low, you will not find enough gain on the faders to bring the signal up to an adequate level.

Microphone Placement Careful microphone placement and the choice of a suitable type of microphone for the job is one of the essentials of successful sound reinforcement. The aim should be to place the microphone as close as physically possible to the source, to cut out unwanted surrounding sounds, allow a lower gain setting on the mixer and avoid feedback. Also a well-chosen and well-placed microphone should not need any appreciable equalisation.

APPLICATIONS

SPIRIT LIVE 4 is designed primarily as a sound reinforcement mixer, but may also be used for basic multitrack recording. The following diagrams show typical configurations which will illustrate how the mixer is connected to other equipment.

Example 1 - Public Address - Stereo Output

In this basic set-up, an assortment of sources are connected to the input channels, microphone to mic. inputs, and a keyboard and guitar to line inputs. Note that some guitars would not produce sufficient level for a direct connection, and would require a D.I. box connected via the microphone input. The mix L/ R outputs are connected to the power amplifier and speakers, and a compressor/ limiter is included in the

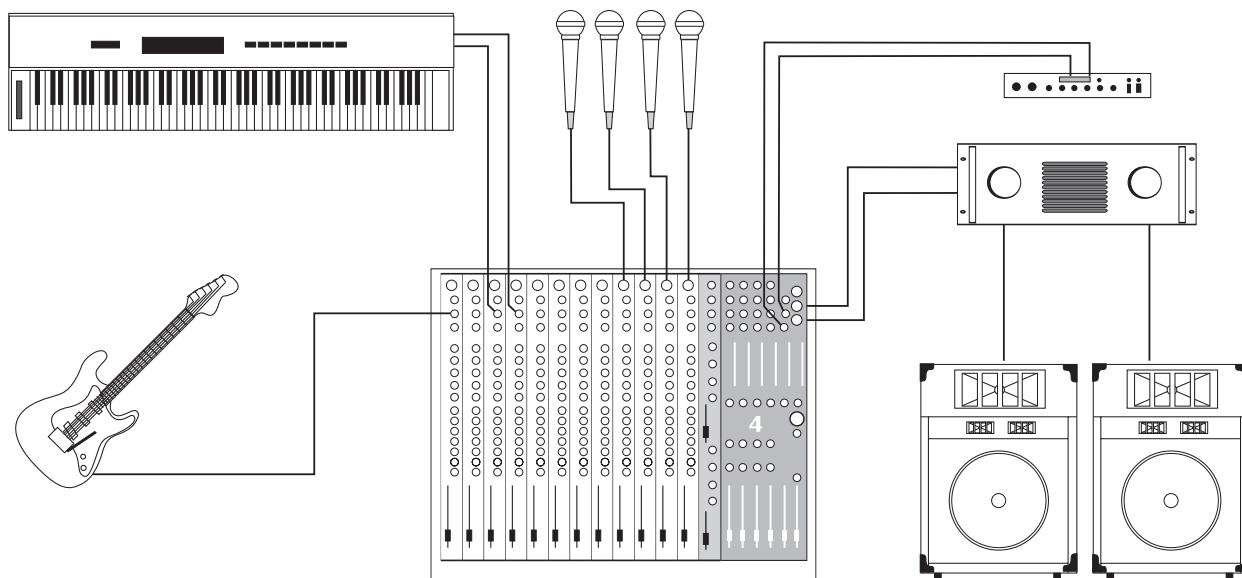

output signal path via the Left and Right insert points.

Example 2: Public Address - Stereo + Centre Feed

In this second example the Group 1 Output is used to drive an additional centre speaker, with individual fader control. The routing on the input channels allows individual selection to

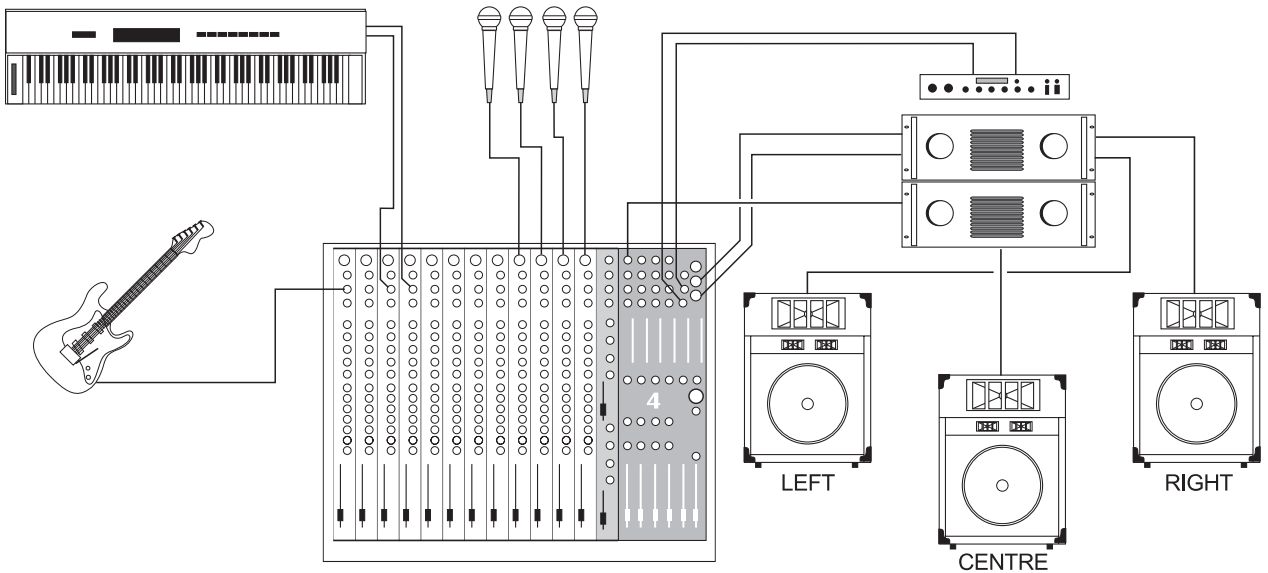

the Centre output by routing to Group 1.

Example 3: Public Address - Mono Output

In this example the console is used to feed loudspeakers in Mono only. The compressor remains in the Left and Right Inserts for use on these outputs if required. A feed from another mixer is submixed to the desk on Returns 1 & 2. Note that the Groups may be used for subgrouping channels to the

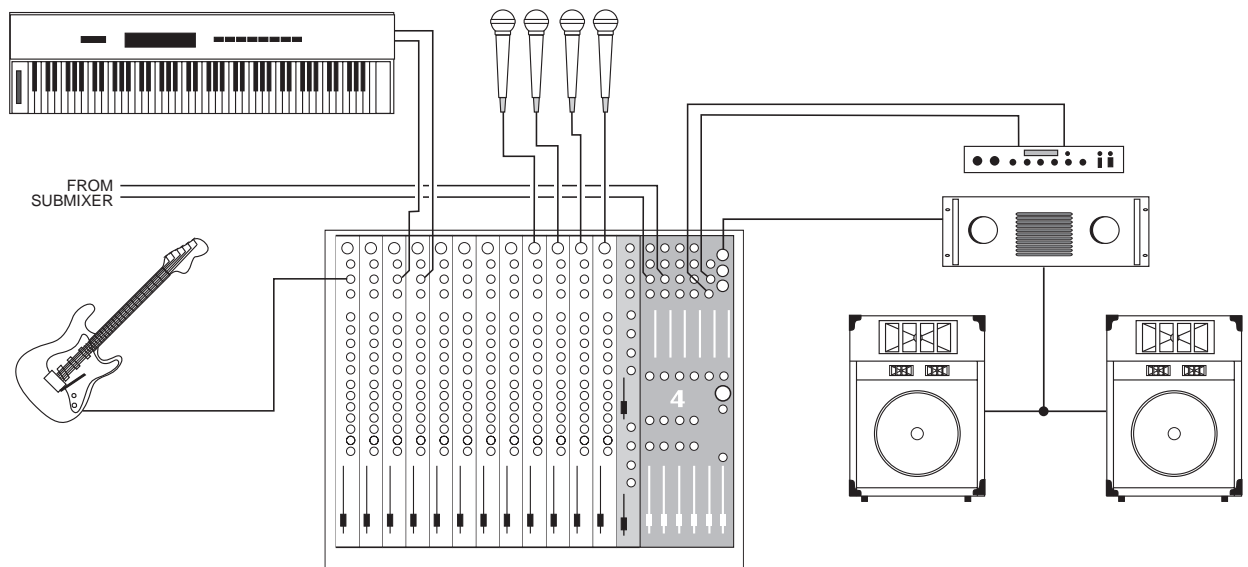

SPiRiT LIVE 4

final output.

Example 4: Stereo Recording

The console may also be used for 2-Track or basic multitrack recording live or in the studio. The set up is similar to the previous examples but with the Mix L/ R Output feeding a 2-track Tape Machine. Aux 1 is used to provide artists foldback on headphones, and Aux 3 and 4 feed a reverb unit

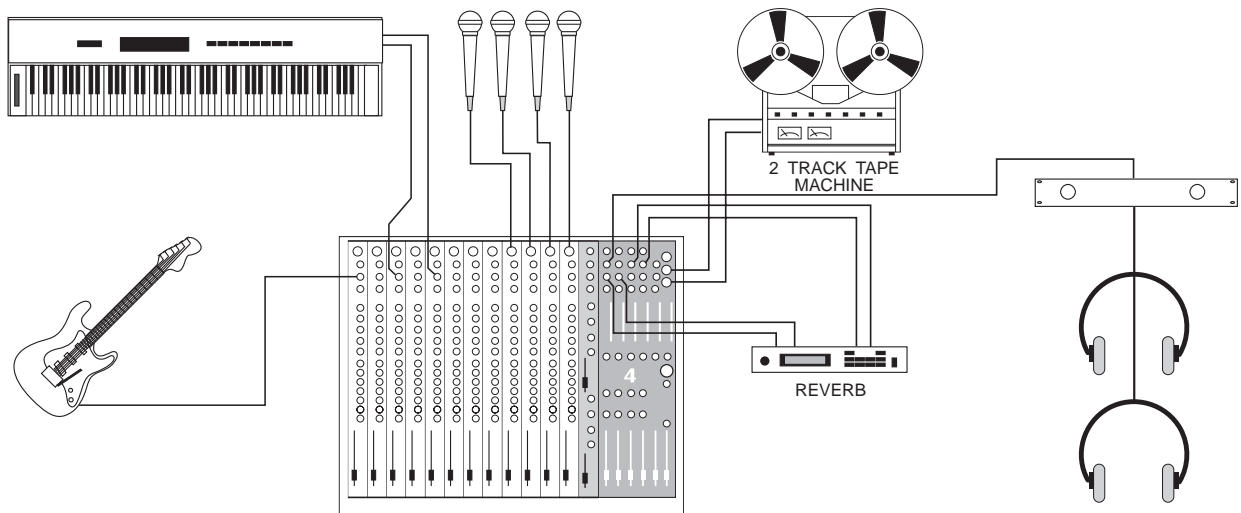

which is returned to the console on RET1 and RET2.

Example 5: Multitrack Recording

In this last example the mixer is connected to a multitrack tape machines, and the main outputs to a 2-track machine for mixdown. Once again a compressor has been included in the insert points.

Feeds to the multitrack are taken from the channel DIRECT outputs. Outputs from tape are fed back to the channel line inputs and can be mixed down to the stereo mix output as required. Aux 3 & 4 feed an effects unit as in the previous

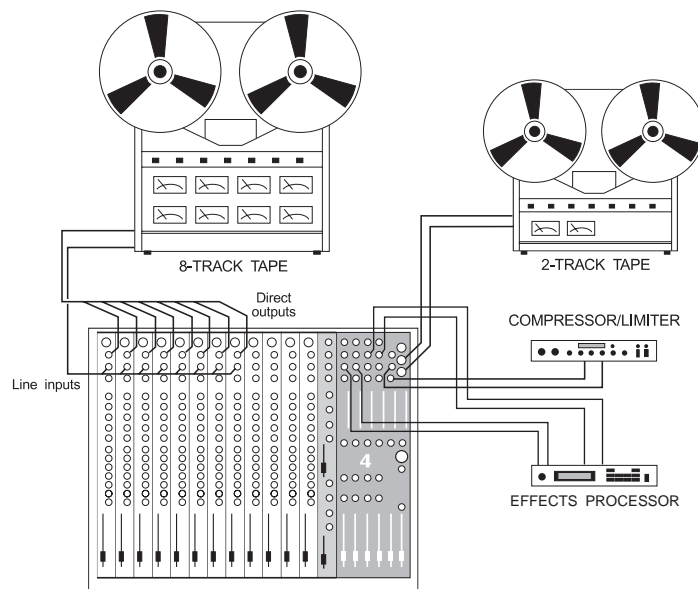



CARE OF YOUR MIXER

General Precautions

Avoid storing or using the mixer in conditions of excessive heat or cold, or in positions where it is likely to be subject to vibration, dust or moisture.

Keep the mixer clean using a soft dry brush, and an occasional wipe with a damp cloth or ethyl alcohol. Do not use any other solvents which may cause damage to paint or plastic parts.

Avoid placing drinks or smoking materials on or near the mixer. Sticky drinks and cigarette ash are frequent causes of damage to faders and switches.

Regular care and inspection will be rewarded by a long life and maximum reliability.

Glossary

auxiliary send	an output from the console comprising a mix of signals from channels and groups derived independently of the main stereo/ group mixes. Typically the feeds to the mix are implemented on rotary level controls.
balance	the relative levels of the left and right channels of a stereo signal.
clipping	the onset of severe distortion in the signal path, usually caused by the peak signal voltage being limited by the circuit's power supply voltage.
dB (decibel)	a ratio of two voltages or signal levels, expressed by the equation $dB=20\text{Log}_{10}(V1/V2)$. Adding the suffix 'u' denotes the ratio is relative to 0.775V RMS.
DI(direct injection)	the practice of connecting an electric musical instrument directly to the input of the mixing console, rather than to an amplifier and loudspeaker which is covered by a microphone feeding the console.
direct output	a post fade line level output from the input channel, bypassing the summing amplifiers, typically for sending to individual tape tracks during recording.
equaliser	a device that allows the boosting or cutting of selected bands of frequencies in the signal path.



feedback	the 'howling' sound caused by bringing a microphone too close to a loudspeaker driven from its amplified signal.
foldback	a feed sent back to the artistes via loudspeakers or headphones to enable them to monitor the sounds they are producing.
frequency response	the variation in gain of a device with frequency.
(sub) group	an output into which a group of signals can be mixed.
headroom	the available signal range above the nominal level before clipping occurs.
highpass filter	a filter that rejects low frequencies.
line level signals	at a nominal level of -10 to +6dBu, usually coming from a low impedance source.
mono output	a mono sum of the left/ right mix outputs, providing a separately controlled line level feed for additional loudspeakers.
pan (pot)	abbreviation of 'panorama': controls levels sent to left and right outputs.
peaking	an equaliser response curve affecting only a band of frequencies i.e. based on a bandpass response.
PFL (pre-fade listen)	a function that allows the operator to monitor the pre-fade signal in a channel independently of the main mix.
rolloff	a fall in gain at the extremes of the frequency response.
shelving	an equaliser response affecting all frequencies above or below the break frequency i.e. a highpass or lowpass derived response.
spill	acoustic interference from other sources.
talkback	the operator speaking to the artistes or to tape via the auxiliary or group outputs.
transient	a momentary rise in the signal level.
+48V	the phantom power supply, available at the channel mic inputs, for condenser microphones and active DI boxes.

Selectable Options

Removal of +48V on Mic Inputs

To disable the +48V phantom powering on the microphone inputs, remove link J3 from Input PCB SC3209. This can be done without removing the PCB as shown below, by carefully cutting the leads of the link above the PCB at the points marked.

To reinstate the +48V, fit a replacement link, Part No. AZ2222, which is available from your dealer.

INPUT BOARD SC3209

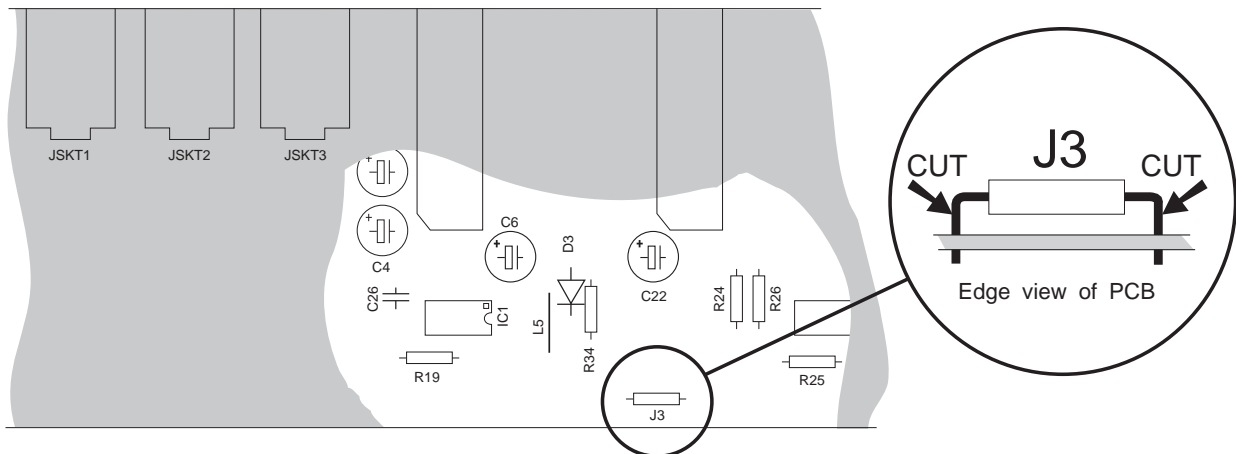

Reconfiguring Aux 2 as a Post Fade Send

Aux 2 is configured as a PRE FADE send at the factory, but may be altered to be POST FADE if required by repositioning a link on the Input PCB SC3209 as shown below.

INPUT BOARD SC3209

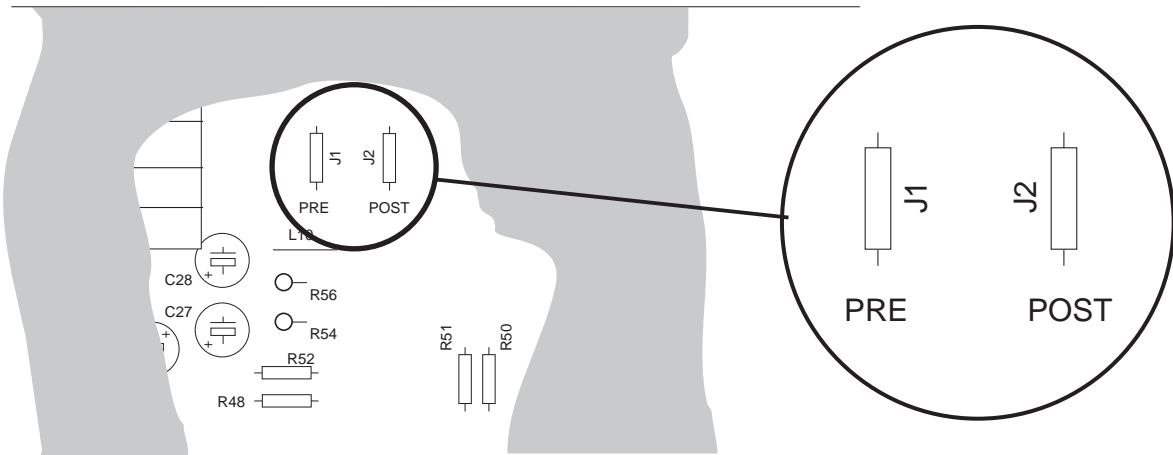

To change AUX 2 to POST FADE, remove the PCB from the console and carefully unsolder link J1 using the minimum of heat to avoid the possibility of tracks lifting on the PCB. Replace the link in position J2.

This operation should only be carried out by competent technicians who possess the necessary soldering skills.



DISTORTION

THD measured at +20dBu

Line Input to Mix Output < 0.0025% @ 1kHz, < 0.015% @ 10kHz

INPUT & OUTPUT IMPEDANCES

Microphone Input	> 2k Ω
Line Input	> 10k Ω
Insert Sends	75 Ω
Insert Returns	10k Ω
Outputs	75 Ω

INPUT & OUTPUT LEVELS

Mic Input Maximum Level	+10dBu
Line Input Maximum Level	+30dBu
Mix Out Maximum Level	+21dBu
Mono Out Maximum Level	+21dBu
Aux Out Maximum Level	+21dBu

METERING

12 Segment LED Bargraph

Accuracy Relative to 0dB +/- 1dB

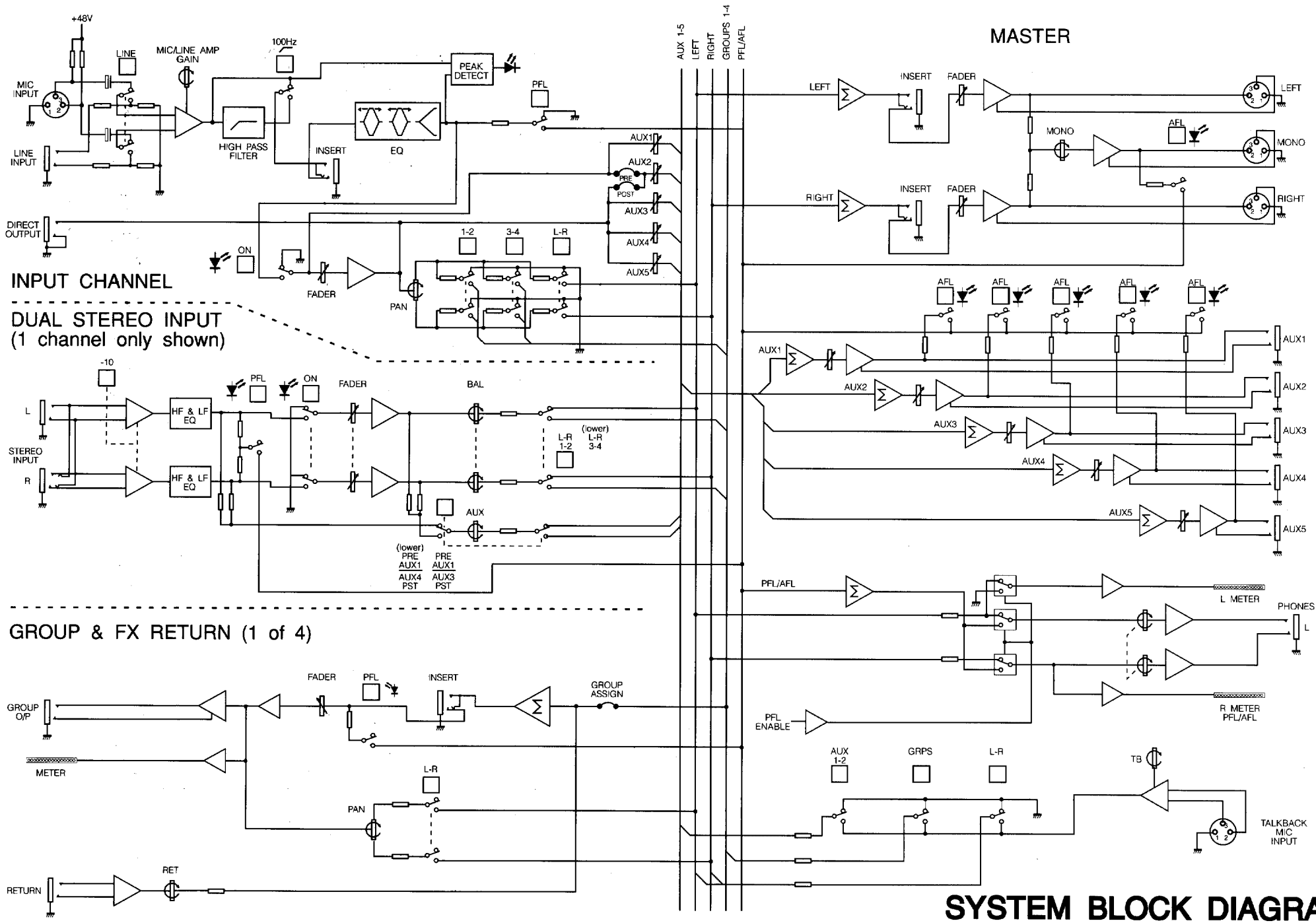

SYSTEM BLOCK DIAGRAM



**Unit C6, Hastingwood Trading Estate
35, Harbet Road, London, N18 3HU**

Phone 020 8803 7400

email office@gradav.co.uk

FAX 020 8803 5060

Web www.gradav.co.uk